

Montageanleitung* BLACK BULL Regalschutz-Planke A

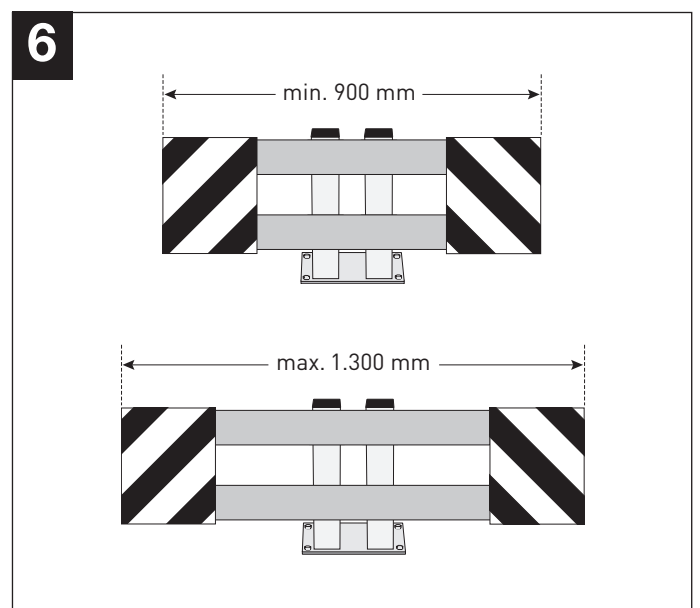
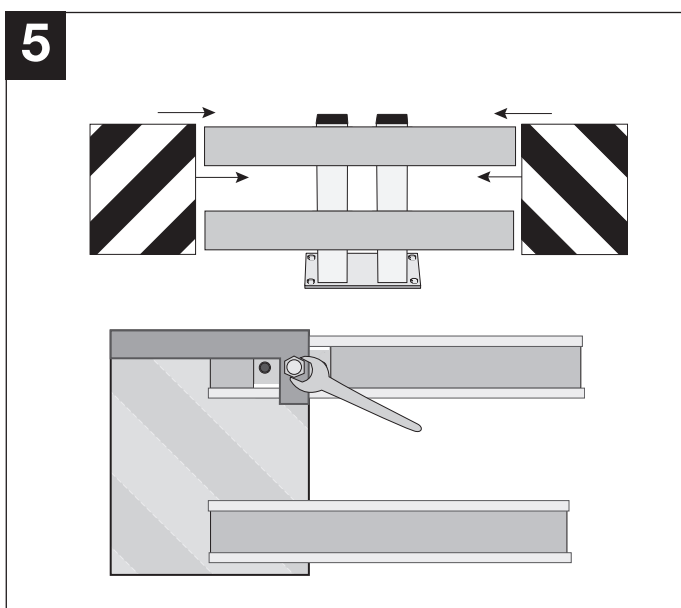
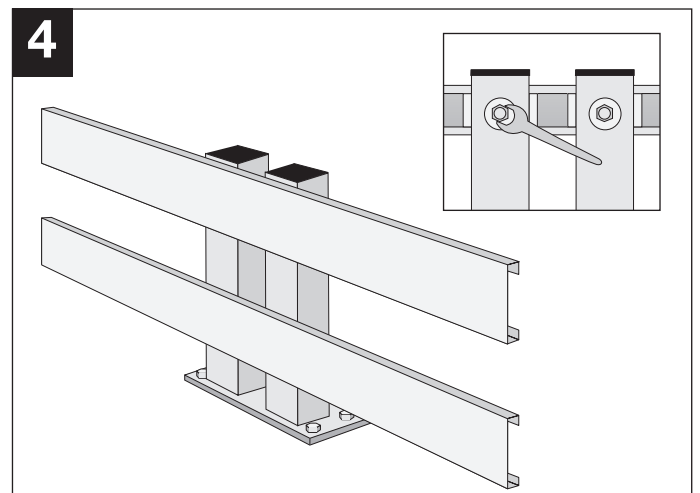
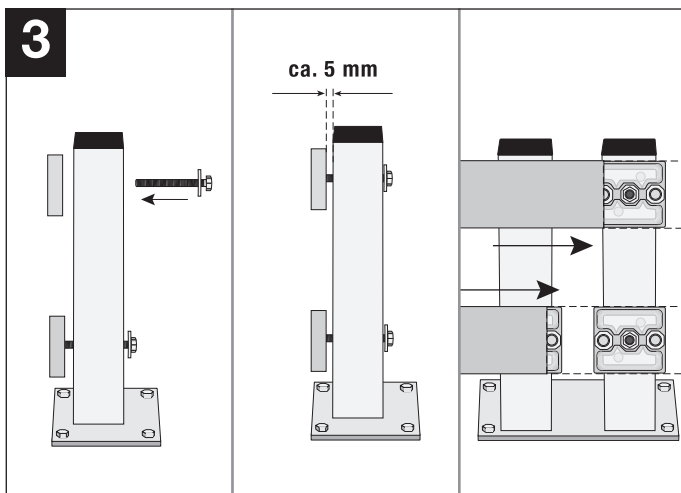
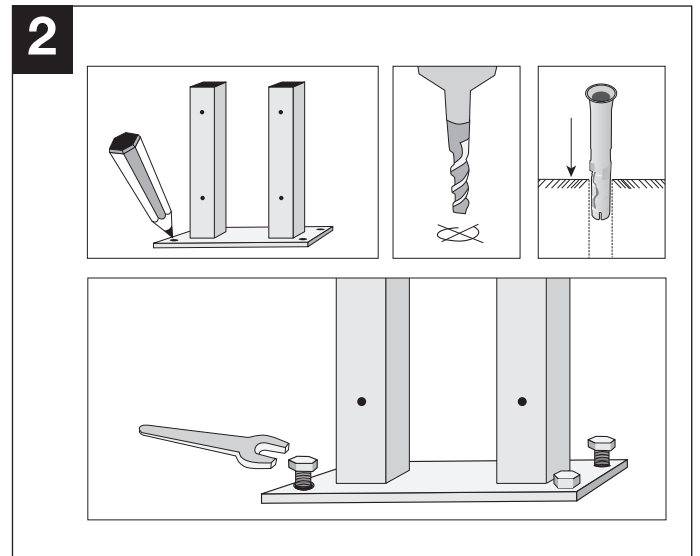
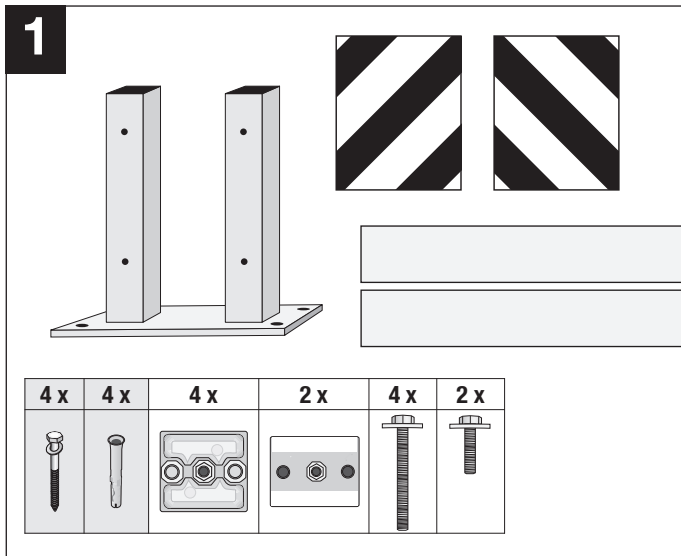

*Bitte lesen und aufbewahren!

WM 1476_1